



StatWireless

www.statwireless.com

sales@statwireless.com

TS830 Touchscreen Programmable Thermostat 111227

Installation, Mounting:

CAUTION:

1. Turn off any electronic source and the electrical devices (e.g. heating and cooling equipment) which will be connected before installation and maintenance.
2. The installer must be a trained HVAC technician.

1. Installation Location:

The thermostat should be mounted on an inner wall 60" above the floor in position where it is readily affected by changes of the general room temperature with freely circulating air. Prevent direct exposure to sunlight; dripping or splashing area. Do not place this unit at a location where air circulation is low, or where it has great temperature changes (e.g. near door). Do not place the thermostat near heat generating sources (radiators, hot air vents, TV or lights).

2. Wiring:

For heat pump

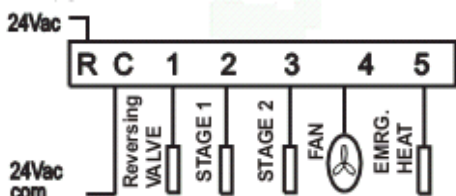

There are 7 terminals. Connect R and C to the 24V power supply. Connect terminal 1 for reversing valve, terminal 2 and 3 are stage1 and stage2 respectively. Terminal 4 is the fan and terminal 5 is the emergency heat.

For AC

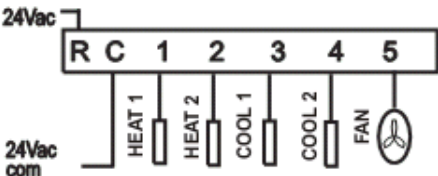

There are 7 terminals. Connect R and C to the 24V power supply. Terminal 1 and 2 are stage 1 and stage 2 heating, terminal 3 and 4 are stage 1 and stage 2 cooling. Terminal 5 is fan.

Caution:

- TURN OFF any electrical devices before wiring.
- Push all cables back into wall prior to affixing to wall in order to avoid trapping wires.
- Do not use metal conduit or cable provided with a metal sheath.

3. Mounting:

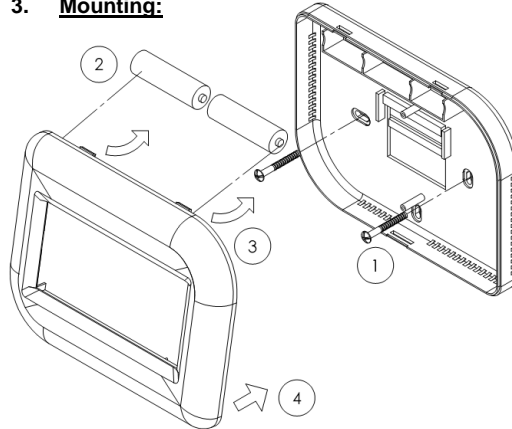

1. Base housing
 - Adjust the base on the wall or junction box and ensure the base is at surface level and that it covers the junction box.
 - If necessary, pull the cables out at the middle hole of the base
 - Place the 2pcs of wall anchors at the wall if necessary.
 - Fasten the base with the 2pcs of long screws.
2. Insert the 2XAA batteries into the thermostat battery case (Pay attention to battery poles)
3. Hold the thermostat on the base. Align the screw blocks with the pins at the back of the thermostat.
4. Push the thermostat straight onto the base until it snaps into place.

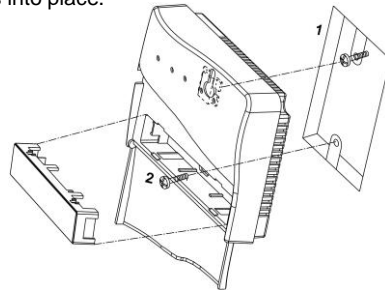

Receiver:

1. Using the accessory screws and wall anchors provided, mount the receiver with the key-hole at the back.
2. Open the front door and remove the battery compartment that hide the second screw hole. (This unit does not use battery; the battery compartment is a dummy to cover the screw hole.)

Feature list:

- Battery powered (2 "AA" alkaline batteries)
- 7 days programs (Mon to Sunday). 4 separate time and temperature settings for each program
- Temperature display in °F or °C
- Temperature Measurable Range: 32 – 99 °F / 0 – 40 °C
- Program Copy for fast programming
- EEPROM stores heat and cool program settings
- Program Override mode (Temporary or Permanent)
- Real clock in 12hr/ 24hr
- Adjustable Check Filter Interval time
- Adjustable Energy Usage Check time
- Adjustable Temperature Control Span
- LCD Backlighting
- Counter for counting Filter, Energy, UV lamp Usage
- Energy Usage Counter
- Calculation for Energy Saving Index
- Defrost Function
- Cleaning screen mode
- Calendar (DST function included)
- Security mode

Communication Setup

1. Select the communication address at the transmitter (thermostat)
2. Select the same communication address at the receiver
3. Power on the transmitter (thermostat)
4. Power on the receiver
5. Receiver's Power LED should light up.

In case the RF receiver is interfered by other wireless products, power OFF the receiver and change to other address. Redo the above steps with another address to reestablish a communication with the receiver.

System Setup mode

There are 10 settings in the setup mode:

1. Calendar
2. 24/12 hours selection
3. C/F display selection
4. Fan HE/HG selection
5. AC/ heat pump selection
6. Number of stages control selection
7. Span and differential Selection
8. Delay/ Long delay selection
9. DST (Daylight savings time) selection
10. Screen lock selection

Hold "SYSTEM" for 5 seconds to enter the setup mode. In setup mode, press "EXIT" to return the normal mode and any changes made to the current setting will not be saved. Press "CONFIRM" to save the current setting and move forward to the next setting.

Calendar

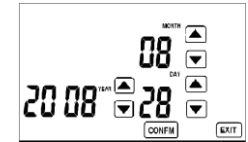

Press / to change the year, month and year

24/12 hours

Press / to choose either 12h (12 hours) or 24h (24 hours) representation.

C/F display

Press / to change temperature unit to display in °C/°F

Fan HE/HG

	Heat On	Cool On
HE	Fan On	Fan On
HG	Fan Off	Fan On

AC/ heat pump selection

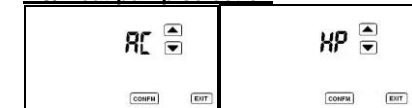

Press / to select "AC" – AC or "HP" – Heat pump.

Number of Stages control selection



Press / to select number of stages in the heating and cooling system.

Span and differential selection



"P" represents Span setting and will be displayed in either °C or °F, "D" represents Differential setting Press / to change the setting.

Delay/ Long delay

Press / to change:

Delay "dE" / Long delay "L dE" selection. Delay for Heat on and Cool on is to prevent short cycling of system.

	Delay	Long delay
Heat mode of AC	10 sec	4 mins
Heat mode of HP	2 mins	4 mins
Emergency heat	10 sec	4 mins

Cool mode	2 mins	4 mins
-----------	--------	--------

DST (Daylight savings time)

Press or to turn on or off DST function. If the date is in the DST period, the clock will be auto activated,

Remark: The DST bases on the USA time zone.

Security lock

Press or to turn on/off the screen lock function. When "On" is selected, a 4-digit password is required.

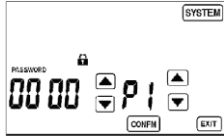

The screen shows a 4-digit password. Press / on the left to change the password number. P1 represents the 1st digit password (read from left), which is selected. After setting all 4 digits, press "CONFIRM" to activate the security mode and it will return to normal mode automatically. When security mode is activated, "🔒" is shown on the LCD and all keys are disabled except "SYSTEM".

Disable the security mode.

1. Press "SYSTEM" and enter the correct password.
2. If the password is correct, security mode will be deactivated. Otherwise the security mode remains activated.

Calendar Read

1. Press the Weekday to show current date.
2. Press the "EXIT" to return the normal mode or it will automatically return to normal mode after idling for 20 seconds

Clock setting

1. Press "CLOCK" to enter the clock setting mode.
2. Firstly, the hour is shown. Press / to change the hour. Press "CONFIRM" to save the setting.
3. Then, the minute is shown. Press / to change the minute. Press "CONFIRM" to save the setting and return the normal.

Fan Setting

When FAN is in AUTO, fan will be turned on according to relay status and HE/HG selection. If ON is selected, then it is always turned on regardless to system status.

Cleaning screen mode

1. Press "CLEAR" to enter the cleaning screen mode
2. There is a 20 seconds count down.
3. During counting, all keys are disabled.
4. When the counting is done, press "EXIT" to return to normal mode or press "CLEAR" to repeat the count down.

Usage

TS830 can record the Filter Usage, UV usage and energy usage. The counters count in hour. Each counter is 4-digital long (0~9999). Filter usage starts

counting when the fan is turned on. UV usages start counting as long as TS830 is turned on. Energy usage counts when either Heat or Cool is on. When the counts reach the set interval, the corresponding usage icons will be shown.

1. Press "USAGE" to enter the usage mode.
2. Filter counter, UV counter and Energy counter are shown alternatively by pressing "USAGE"
3. Press "CLEAR" to clear the counts.
4. Press "EXIT" to exit the usage mode.

Adjusting Usage Interval Time

1. Hold the "USAGE" for 5 seconds during the usage mode.
2. Press / to change the internal time (0~9999).
3. Press "CONFIRM" to save the setting
4. Press "EXIT" to exit the interval setting.

Press "CLEAR" to clear USAGE counter.

Defrost

When the room temperature is below or equal to 5°C / 40°F, HEATING will always be turned ON and COOLING will always be turned OFF irrespective to the current control temperature set. "❄️" defrost indicator will be shown.

Program mode

1. Press "PROG" to enter the program mode.
2. Default start from "MON" and "WAKE".
3. Current program of setting is without
4. Press / to change the time, heat/cool setting temperature.
5. Press "EXIT" to back to normal mode
6. Press "CONFIRM" to save setting and return to normal mode
7. Press "COPY" to copy the program.

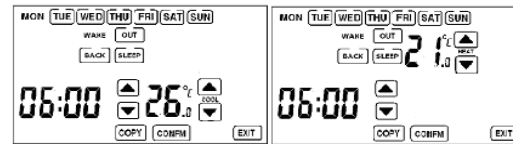

8. During the copying process, the heat/cool setting temperatures can be checked by pressing "WAKE", "OUT", "BACK" and "SLEEP"
9. Press other days with which you want to copy the program to. Days that are selected will have no shown on the LCD.



10. Press "COPY" again to finish the copy mode and

return to program setting mode.

Default program settings are shown as below

Heat mode

	Wake	Out	Back	Sleep
Mon	6:00 (21°C / 70°F)	8:00 (16°C / 61°F)	18:00 (21°C / 70°F)	22:00 (16°C / 61°F)
Tue	6:00 (21°C / 70°F)	8:00 (16°C / 61°F)	18:00 (21°C / 70°F)	22:00 (16°C / 61°F)
Wed	6:00 (21°C / 70°F)	8:00 (16°C / 61°F)	18:00 (21°C / 70°F)	22:00 (16°C / 61°F)
Thu	6:00 (21°C / 70°F)	8:00 (16°C / 61°F)	18:00 (21°C / 70°F)	22:00 (16°C / 61°F)
Fri	6:00 (21°C / 70°F)	8:00 (16°C / 61°F)	18:00 (21°C / 70°F)	22:00 (16°C / 61°F)
Sat	6:00 (21°C / 70°F)	10:00 (16°C / 61°F)	18:00 (21°C / 70°F)	23:00 (16°C / 61°F)
Sun	6:00 (21°C / 70°F)	10:00 (16°C / 61°F)	18:00 (21°C / 70°F)	23:00 (16°C / 61°F)

Cool mode

	Wake	Out	Back	Sleep
Mon	6:00 (26°C / 79°F)	8:00 (29.5°C / 85°F)	18:00 (26°C / 79°F)	22:00 (28°C / 82°F)
Tue	6:00 (26°C / 79°F)	8:00 (29.5°C / 85°F)	18:00 (26°C / 79°F)	22:00 (28°C / 82°F)
Wed	6:00 (26°C / 79°F)	8:00 (29.5°C / 85°F)	18:00 (26°C / 79°F)	22:00 (28°C / 82°F)
Thu	6:00 (26°C / 79°F)	8:00 (29.5°C / 85°F)	18:00 (26°C / 79°F)	22:00 (28°C / 82°F)
Fri	6:00 (26°C / 79°F)	8:00 (29.5°C / 85°F)	18:00 (26°C / 79°F)	22:00 (28°C / 82°F)
Sat	6:00 (26°C / 79°F)	10:00 (29.5°C / 85°F)	18:00 (26°C / 79°F)	23:00 (28°C / 82°F)
Sun	6:00 (26°C / 79°F)	10:00 (29.5°C / 85°F)	18:00 (26°C / 79°F)	23:00 (28°C / 82°F)

Override mode

1. Press to select permanent override, temporary override and program.
2. Default heat and cool setting temperature for override and permanent override mode is 26°C / 79°F
3. Press / to change the override setting temperature in heat and cool mode respectively.

Temporary override returns to program mode when matches next program setting time.

System setting

In Normal mode, press "SYSTEM" to enter System mode. System mode is set in the sequence of: HEAT → COOL → OFF → HEAT...

System Mode	
HEAT MODE	Relay will be turned on when the room temperature is lower than the setting temperature
COOL MODE	Relay will be turned on when the room temperature is higher than the setting temperature
OFF MODE	Relay will always be turned off at any temperature.
EM. HEAT	Relay will be turned on when the room temperature is lower than the setting

	temperature (only can selected in Heat Pump system)
--	---

"LO" will be shown when room temperature is below 0°C / 32°F

"HI" will be shown when room temperature is above 40°C / 99°F

Energy saving index:

In the system mode, the energy saving index uses the program setting temperature for calculating the energy saving and the energy saving index, which is displayed on the LCD.

Daily energy saving index is calculated by the daily difference in setting temperature and standard temperature. Combine all 7 days daily energy saving index will give the weekly energy saving index, which is the value shown on the LCD.

The standard temperature is 21°C / 70°F in winter and the standard temperature is 26°C / 79°F in summer.

If the setting temperature is higher than standard temperature (in winter) or lower (in summer), then the saving becomes a loss

If the net weekly saving is positive, the saving percentage is displayed with the <SAVE>.

If the net weekly saving is negative, the saving percentage is displayed with the <LOSE>.

There is no energy saving index in off mode.

If the energy saving index is larger than 99%, <HI> is displayed with <SAVE> / <LOSE>.

Low battery

If the voltage batteries drop below 2.7V, icon will be on.

The battery is detected every hour.

Electrical Interface

Temperature measurement:	0~40°C / 32~99°F
Control temperature range:	5~35°C / 41~95°F
Temperature resolution:	0.5°C / 1°F
Temperature accuracy:	±0.5°C / ±1°F
Transmitter input voltage:	2 X AA alkaline battery
Receiver Input voltage:	24 Vac 50/60Hz
Relay contact Current:	1A Max
Operating Temperature:	0 ~ 50°C
Storage Temperature:	-10 ~ 60°C

Limited One-Year Warranty for ICS products

INFORMATION FOR CONSUMERS:

The ("Buyer") is eligible for the warranty listed below only for products which contain the "ICS" label:

- Thermostats and thermostat wall plates are warranted for 1 year from the date of purchase or 2 years from the date of manufacture, whichever comes first (this warranty excludes consumables such as batteries).

Subject to the limitations set forth herein, Seller warrants that the Goods purchased for resale hereunder will be free from defects in material and workmanship under normal use and regular service and maintenance.

This warranty shall not apply to any Goods which:

1. Have been repaired or altered outside Seller's factory by other than Seller in any manner that, in Seller's Judgment, affects its serviceability or proper operation.
2. Have been subjected by persons other than Seller to improper handling, operation, maintenance, repair or alteration.
3. Have been subjected to misuse, negligence, improper installation or accident.

Seller's obligation under this warranty, and the Buyer's exclusive remedy for the breach thereof, shall be limited to, at Seller's option, replacement of any alleged defective Goods or issuance of credit, excluding the cost of labor and any other expenses incurred in servicing the unit on which the Goods are installed. All returned Goods are subject to inspection, and if examination by Seller does not disclose any defect covered by this warranty, replacement of such Goods or issuance of credit for same will not be approved.

THE FOREGOING CONSTITUTES SELLER'S SOLE WARRANTY RESPONSIBILITY AND BUYER'S EXCLUSIVE REMEDY WHETHER SOUNDING IN TORT, CONTRACT, STRICT LIABILITY OR OTHERWISE, EXCEPT AS OTHERWISE EXPRESSLY SET FORTH IN THIS AGREEMENT. THERE ARE NO OTHER WARRANTIES, EXPRESS OR IMPLIED, WHETHER OF MERCHANTABILITY, FITNESS FOR A PARTICULAR PURPOSE OR OTHERWISE, SELLER SHALL NOT BE LIABLE FOR ANY SPECIAL, INDIRECT, INCIDENTAL OR CONSEQUENTIAL DAMAGES OF ANY CHARACTER IN CONNECTION WITH THE SALE, RESALE OR USE OF THE GOODS.

LIMITATION OF REMEDY AND LIABILITY: THE SOLE AND EXCLUSIVE REMEDY FOR BREACH OF ANY WARRANTY HEREUNDER SHALL BE LIMITED TO REPAIR, CORRECTION, REPLACEMENT OR CREDIT.

SELLER SHALL NOT BE LIABLE FOR DAMAGES CAUSED BY DELAY IN PERFORMANCE, REGARDLESS OF THE FORM OF THE CLAIM OR CAUSE OF ACTION (WHETHER BASED IN CONTRACT, INFRINGEMENT, NEGLIGENCE, STRICT LIABILITY, OTHER TORT OR OTHERWISE), AND IN NO EVENT SHALL SELLER'S LIABILITY TO BUYER AND/OR ITS CUSTOMERS EXCEED THE PRICE PAID BY BUYER FOR THE SPECIFIC GOODS PROVIDED BY SELLER GIVING RISE TO THE CLAIM OR CAUSE OF ACTION, AND BUYER SHALL INDEMNIFY SELLER FOR ANY DAMAGES IN EXCESS THEREOF. BUYER AGREES THAT IN NO EVENT SHALL SELLER'S LIABILITY TO BUYER AND/OR ITS CUSTOMERS EXTEND TO INCLUDE INCIDENTAL, CONSEQUENTIAL OR PUNITIVE DAMAGES, WHICH ARE WAIVED BY BUYER AND AS TO WHICH BUYER SHALL INDEMNIFY SELLER.

The term "consequential damages" shall include, but not be limited to, loss of anticipated profits, business interruption, loss of use of revenue, cost of capital or loss or damage to property or equipment, or loss of reputation.

Further, Buyer shall indemnify and hold Seller harmless from any liability to Buyer, Buyer's employees, workers, contractors or any other person arising out of Buyer's or any other person's, use of the Goods. It is further expected and Buyer agrees that all instruction and warnings supplied by Seller will be passed on to those persons who use the Goods. Seller's Goods are to be used in their recommended applications and all warning labels adhered to the Goods by Seller are to be left intact.

It is expressly understood that any technical advice furnished by Seller with respect to the use of the Goods is given without charge, and Seller assumes no obligation or liability for the advice given, or results obtained, all such advice being given and accepted.